

2024 DIXIE NATIONALEQUESTRIANS WITH DISABILITIES PARA REINING
CLASS 265

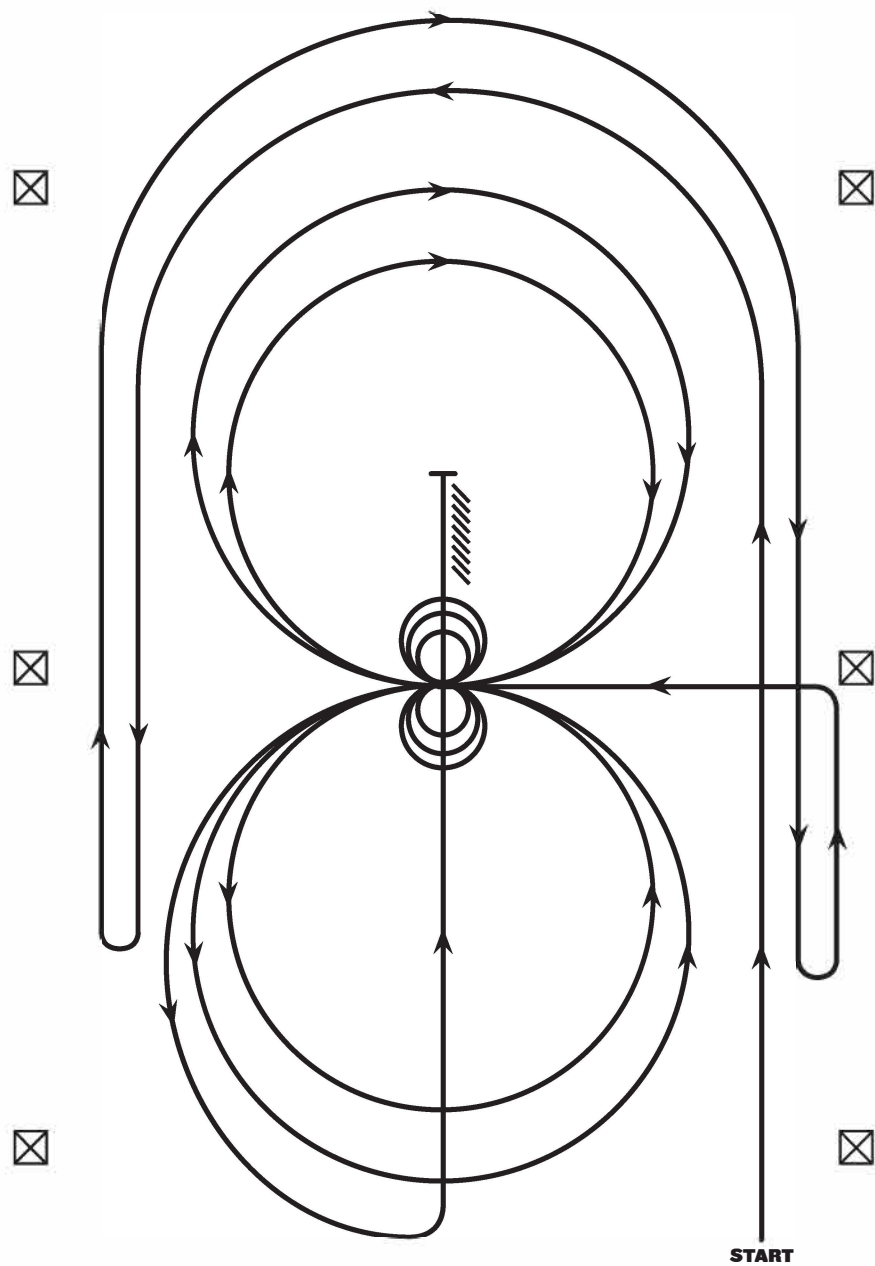

1. Run around the end of the arena, run down the left side past center marker, right rollback
2. Run around end of arena, run down right side past center marker, left rollback
3. Left circles, one large fast and one small slow, stop at center
4. 3 spins left, hesitate
5. Right circles, one large fast and one small slow, stop at center
6. 3 spins right, hesitate
7. Begin large fast circle to left at the top of the circle, run down the center of arena past center marker, stop.
8. Back up at least 10 feet. Hesitate to show completion of pattern.